CSIRO PUBLISHING

Marine & Freshwater Research

Volume 51, 2000
© CSIRO 2000

A journal for the publication of original contributions
in physical oceanography, marine chemistry,
marine and estuarine biology and limnology

www.publish.csiro.au/journals/mfr

All enquiries and manuscripts should be directed to

Marine and Freshwater Research

CSIRO PUBLISHING

PO Box 1139 (150 Oxford St)

Collingwood

Vic. 3066

Australia

Telephone: 61 3 9662 7618

Facsimile: 61 3 9662 7611

Email: ann.grant@publish.csiro.au



Published by **CSIRO PUBLISHING**
for CSIRO and
the Australian Academy of Science



A baited underwater video system for the determination of relative density of carnivorous reef fish

Trevor J. Willis and Russell C. Babcock

Leigh Marine Laboratory, University of Auckland, PO Box 349, Warkworth, New Zealand
email: t.willis@auckland.ac.nz

Abstract. Estimates of the relative density of fishes form the basis of many marine ecological studies as well as the assessment of effects of fishing or pollution. Plasticity in the behavioural response of large reef fishes to SCUBA divers means that commonly used underwater visual census (UVC) techniques do not always provide reliable estimates of relative density. The paper describes the system configuration, deployment methods, testing and use of a remotely deployed baited underwater video (BUV) system for the survey of carnivorous reef fishes (snapper, *Pagrus auratus* and blue cod, *Parapercis colias*) in marine reserves of northern New Zealand. Concurrent UVC and BUV surveys inside and outside a marine reserve showed that, whereas UVC detected few snapper in either area (resulting in little confidence in statistically significant results), BUV demonstrated significant differences in relative density. Conversely, blue cod were found to occur at significantly higher densities within the reserve by UVC, but not by BUV. The provision of accurate estimates of fish size (<20 mm error) from video footage also illustrated differences in size structure between protected and fished populations. The data suggest that a combination of survey techniques is likely to be necessary where multispecies assemblages are being assessed.

Extra keywords: abundance estimates, sampling methods, temperate reefs, underwater visual census

Introduction

The ability to make accurate estimates of animal abundance is fundamental to the study of the ecology of those animals (Andrew and Mapstone 1987), as well as providing the basis for the assessment of environmental effects. Such estimates need not be absolute – for many studies it is sufficient to determine relative abundance among sites or times (Connell *et al.* 1998). Regardless of the aims of any given study, data quality and the capacity to detect changes in abundance are dependent on several factors. First, the survey method must be appropriate to the species of interest, taking cognisance of both the spatial scale sampled and the behavioural traits of the target species. Second, the sampling programme must be properly designed, with adequate controls in both time and space (e.g. Hurlbert 1984; Jones *et al.* 1993; Underwood 1993; Edgar and Barrett 1997; Kingsford and Battershill 1998). Finally, any changes in community structure or density of particular species must be of sufficient magnitude to be detected, that is, consistently greater than the scope of background variation.

In studies of reef fish ecology (particularly in shallow tropical environments), abundance estimates are usually obtained by SCUBA divers using variations of underwater visual census (UVC) methods because of their non-destructive nature. The limitations of UVC are well known (e.g. Thresher

and Gunn 1986; Lincoln Smith 1988, 1989; St John *et al.* 1990; Thompson and Mapstone 1997), but the method is still often used, albeit with repeated calls for the use of methodological pilot studies to reduce observer error and enhance the accuracy and precision of data obtained (McCormick and Choat 1987; Cheal and Thompson 1997).

Several recent studies have demonstrated that the accuracy of a single survey method can be variable for sampling multispecies fish assemblages (Hickford and Schiel 1995; Jennings and Polunin 1995; Connell *et al.* 1998; Kulbicki 1998; Willis *et al.* 2000). These problems are distinct from UVC observer error. It has been suggested that multiple methods be used concurrently to obtain overall estimates of abundance (Connell *et al.* 1998; Willis *et al.* 2000). Most of the methods previously compared fall into one of two general categories: direct observation (UVC) and remote capture (e.g. angling, long-lining or gill-netting) techniques. The need for multiple methods relates to interspecific differences in body size, habitat association, aggregative behaviour, mobility, or responses of fish to the presence of divers. At times, these interspecific differences can be systematically biased by the very factor that is under investigation. This is particularly the case for studies of marine reserve effects, where fish behaviour can vary markedly among sites (Cole 1994).

Recent attention given to the concept of marine reserves and their potential use for both conservation and fishery management (Agardy 1994; Roberts 1997; Allison *et al.* 1998; Pauly *et al.* 1998), has generated considerable interest in the potential effects of marine reserves on the biota contained within them. In particular, environmental managers may wish to know whether reserves protect those species most affected by human activity, whether the 'integrity' of whole habitats can be maintained, and what trophic cascade or other ecological 'flow-on' effects (e.g. Babcock *et al.* 1999) may arise from elevations in the density of organisms that are elsewhere depressed to low levels.

In northern New Zealand, the fish species most likely (by virtue of their exposure to past and present fishing pressure) to exhibit signs of recovery in marine reserves are the blue cod *Parapercis colias* (Pinguipedidae), and the snapper *Pagrus auratus* (Sparidae). To date, however, the only fish species effectively demonstrated to have increased in density within New Zealand marine reserves are the red moki *Cheilodactylus spectabilis* at Leigh (McCormick 1989; Cole *et al.* 1990), and *P. colias* at Long Island, Marlborough Sounds (Davidson 1997). Previous efforts to detect statistically significant increases in numbers of *P. auratus* at the Leigh marine reserve have failed (Cole *et al.* 1990; Cole 1994), despite apparently high densities visible in the vicinity of Goat Island (in the centre of the reserve). It was subsequently shown that *P. auratus* in this area exhibited diver-positive behaviour, perhaps brought about by the feeding of fish by recreational divers (Cole 1994). Such variability in behaviour (diver-positive at some sites, and diver-negative at others) means that surveys of *P. auratus* undertaken using SCUBA-based UVC techniques are likely to be confounded.

Here we investigate the use of a remotely operated survey technique, baited underwater video (BUV), to describe relative abundance and size of *Pagrus auratus* and *Parapercis colias* over small spatial scales. Similar concepts have been used elsewhere at slope and abyssal depths, but with considerable differences in the configuration and methods of analysis (e.g. Ellis and DeMartini 1995; Priede and Merrett 1996). Our system configuration, deployment methods and video analysis methods are described, and we estimate measurement accuracy and make field comparisons between estimates of fish relative density derived from BUV and UVC.

Materials and methods

System components

We used a Sony XC-999P high-resolution (752 × 582 picture elements) colour camera, with an automatic CCD (charge coupled device) iris that adjusts according to the amount of incident light. Dimensions of the camera were 22 × 22 × 120 mm. The unit was enclosed in a custom-built waterproof housing, with a rotating lens cover that enabled modification of the iris adjustment range. It was sometimes necessary to partially close the iris manually to prevent image flicker when deploying the camera in strong sunlight. A 100 m long coaxial cable supplied power to, and received image signal from, the camera.

A Sony GV-S50E 8 mm video recorder, with integrated 82 × 63 mm colour LCD monitor, provided a compact format for simultaneous viewing and recording of images. Both the camera and recorder/monitor were powered from a single 12 V, 17.5 A hr sealed lead-acid battery.

The camera stand was built to be as lightweight as possible, so that it could be raised and lowered easily by hand. We also suspected that the use of a more bulky structure would influence the response of fish to the bait. The stand was made of painted steel, and consisted of a single 25 mm diameter vertical pipe with a triangular base and two opposing struts for stability. The camera was mounted on a horizontal strut extending from the vertical pipe at a height of 115 cm, so that it pointed vertically downward at the centre of the hypotenuse of the base (Fig. 1). A bait holder (a perforated plastic jar, 90 mm in diameter) was fitted to the base at the centre of the field of view. Cable ties were tied tightly to the base at ~30 cm intervals, and the exact distance between them was measured once the stand was assembled. These were visible on the screen, and acted as calibration marks for later measurement of fish in the laboratory from digitized images.

The whole assembly was raised and lowered on 8 mm nylon (floating) rope. The cable was tied to the strut and thence to a small float attached to the rope 30 cm above the stand. The use of floating rope and the method of securing the cable were chosen to prevent either the rope or cable from passing under the camera to obscure the view, and to prevent any stress being placed on the delicate cable.

Deployment methods

At the start of each deployment, the location, GPS coordinates, water depth, time of day (NZST), and station number were filmed to identify the subsequent sequence. The bait holder was baited with a consistent quantity (~200 g) of frozen pilchard (*Sardinops neopilchardus*), chopped up to maximize the odour plume. An external bait (a piece of pilchard held in place with a cable tie) was placed on the lid of the bait holder. Pilchard was used because of its high oil content, and proven effectiveness as a bait. The video unit was then lowered to the bottom while it was recording so that sequence timing could be taken from the time contact was made with the bottom. The monitor was watched during deployment to ensure that the stand was stable upon reaching the bottom. The rope and cable were then buoyed at the surface to prevent them sinking into the field of view. To avoid bias due to other food sources, BUV deployments in non-reserve areas were made at sites at least 500 m from diving or fishing activity. All sampling was restricted to daylight hours (0800–1600) so that sampling was not biased by natural daily changes in behaviour (e.g. crepuscular peaks in feeding activity).

Analysis of video footage

At the laboratory, 8 mm videotapes were copied to VHS tapes for analysis and archiving. Videotapes were played back with a real-time counter, and the number of each species of fish present at the bait was recorded at 30 s intervals. The maximum number of snapper (MAX_{sna}) and the maximum number of blue cod (MAX_{cod}) present at the bait during the sequences were recorded, as well as the time from deployment at which each count was made (i.e. t_{MAXsna} , t_{MAXcod}). Footage was monitored constantly (frame-by-frame where necessary) to obtain these maxima. Additionally, the time to arrival of the first snapper (t_{1STsna}), and the first blue cod (t_{1STcod}) were taken, and the persistence of the external bait (t_{BG}) was noted. Individual fish were measured by digitizing video images using the Mocha image analysis system (Jandel Corporation) and obtaining a three-point calibration (to compensate for wide-angle distortion) for each image using the marks visible on the base of the stand. Measurements were made only of those fish present when the count of the maximum number of fish of a given species in a sequence (e.g. MAX_{sna}) was made. Although this means that some fish moving in and out of the field of view may not have been measured, it also avoids repeated measurement of the same individuals. It is likely that this approach results in more conservative

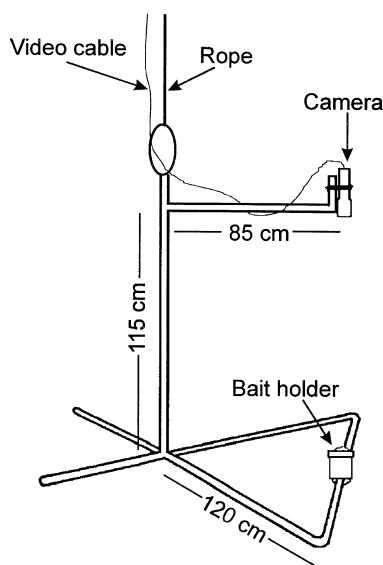

Fig. 1. Baited underwater video assembly, with dimensions of the stand.

abundance estimates in high-density areas than low-density areas, and therefore observed relative differences between reserve and non-reserve sites are also likely to be conservative.

Measurement accuracy

Measurement accuracy of fish length from digitized images was determined by deploying the camera and filming plastic fish models of various lengths (held by a diver), and comparing video estimates of total length with the actual measured length of the model. Repeated video measurements were made of each model at several positions within the field of view, to provide estimates of measurement error.

Duration of BUV deployments

The most reliable BUV index for both snapper and blue cod was the MAX index (Willis *et al.* 2000, and see Results). The duration of BUV deployment required to reliably detect among-site differences in snapper and blue cod abundance using the MAX index was determined in two ways. First, the times at which MAX_{sna} and MAX_{cod} occurred during a series of 30 min sequences taken in ($n = 15$) and around ($n = 21$) the Te Whanganui a Hei (Hahei) marine reserve ($36^{\circ}49'S, 175^{\circ}47'E$) were compiled. Each sequence was divided into 5 min blocks, and mean counts after each block were plotted to determine if reserve *v.* non-reserve differences were consistent for different deployment durations. Maximum drop time was limited to 30 min because the decay rate of the bait odour plume was unknown, and because of limited vessel time in which to obtain sufficient replicate samples. In addition, three 60 min deployments were later taken within areas of high fish density (Millar and Willis 1999; Willis *et al.* 2000) in the Leigh marine reserve, to establish whether increasing deployment time caused any substantial difference to the abundance estimates.

Large-scale comparison of snapper and blue cod abundance

Concurrent BUV and UVC surveys were undertaken at the Hahei marine reserve during April 1998. For both survey methods, the reserve was divided into three sampling areas, and four adjacent non-reserve areas were defined for comparison so that the depth and habitat ranges were comparable. Five replicate BUV deployments were haphazardly distributed throughout each of the seven areas. The MAX_{sna} and MAX_{cod} indices were used as measures of abundance for analysis.

Underwater visual census consisted of three 25×5 m transects carried out by three divers at each site, giving nine replicate transects per site. Divers fastened a fibreglass tape to the substratum, then swam 5 m before commencing counts to avoid sampling fish attracted to the diver. The tape was swum out to 30 m, with all fish visible 2.5 m either side of the swim direction included. The lengths of all snapper and blue cod were estimated to the nearest 5 cm. Occasionally, blue cod would follow divers between transects, and care was taken not to include these individuals in subsequent transect replicates. Divers were trained to estimate fish size prior to the survey by practising on plastic models placed at varying distance from a simulated transect line. The number of dive sites completed per area was influenced by weather and visibility (dives were aborted if water visibility was <5 m), but at least two sites were completed in each survey area. As with the video deployments, dive sites were distributed throughout the survey areas, but exact localities were rarely duplicated by the two methods.

Rarely are count data appropriately modelled by linear models such as ANOVA, because the data usually violate the underlying assumption of normality (e.g. Power and Moser 1999). This is often due to the modal sample value being zero, and such data are best modelled by use of the negative binomial or Poisson distributions (Willis *et al.* 2000). Here, we estimate the difference between reserve and non-reserve means using a log-linear fixed-effects model fitted using the SAS procedure GENMOD. Mixed-effects models were fitted to UVC data (with diver and site as random effects) to account for possible overdispersion, using the SAS macro GLIMMIX (for explanation of this method see Millar and Willis 1999). There is at present no way of formally estimating statistical power from the log-linear model. However, as the log-linear estimates of effect size differed little from arithmetically derived values, the minimum sample size required by BUV and UVC to detect a three-fold difference in fish density between reserve and non-reserve sites (with specified statistical power of 0.8) was determined by *post hoc* statistical power calculations (Zar 1984).

Pairwise, small-scale estimates of blue cod density

The accuracy of video-based estimates of localized blue cod abundance was tested by comparing video samples with dive-transect estimates at ten sites inside and six outside the Leigh marine reserve ($36^{\circ}16'S, 174^{\circ}48'E$). The camera was deployed for 30 min and retrieved, and fish attracted to the bait were allowed to disperse for 20 min before two divers performed three replicate 25×5 m transects each. The divers counted all blue cod within the transects, and estimated their size. Pairwise comparisons were made between the total number of cod counted by UVC and the BUV indices described above. Small-scale comparisons were not attempted with snapper because of known behavioural biases (Cole 1994), but blue cod are benthic fishes with relatively low mobility, and we therefore had greater confidence in UVC estimates of their abundance.

Results

Accuracy of BUV measurement

Overall mean error in the size measurement of model fish was an overestimate of 16.9 ± 2.4 (s.e.) mm. Most of the measurement error occurred because measured objects were closer to the camera than the calibrated plane (which is at the base of the stand). Fish size could not be underestimated, because they cannot swim lower than the sea floor. In practice, repeated observation showed that snapper often approached the bait at a height level with the top of the bait holder, magnifying the measured length. This error was accounted for by measuring the diameter of the bait container, and scaling down the measured fish length by the observed

container error (usually by 10–20%). Fish that passed through the field of view higher than the bait container were not measured. Measurements of blue cod length were more accurate, because this species habitually rests on the bottom. Mean measurement error of <20 mm (in this case <10% of fish length) was considered acceptable, because diver estimates of lengths of large demersal fish are unlikely to be accurate if using size classes of <50 mm (Bell *et al.* 1985).

Duration of BUV deployments

Numbers of visible snapper increased with BUV deployment time. However, varying the length of deployment had little effect on the ability of the method to detect differences in abundance. Statistically significant differences ($\chi^2 = 10.08$, *df* 1,34, $P < 0.01$) were found between reserve and non-reserve sample means for snapper when deployment lasted only 5 min (Fig. 2a). Subsequent mean increases show that fish continued to accumulate at the bait in both reserve and non-reserve areas, albeit more rapidly inside the reserve, so that the statistical significance of reserve *v.* non-reserve comparisons increased with deployment time. An average 70% of snapper detected after 60 min deployments were detected after the first 30 min (Fig. 3). The highest mean rate of accumulation at the bait occurred between 25 and 30 min, and no further fish were detected after 50 min deployment time.

The maximum abundance of blue cod occurred after 20 min in both reserve and non-reserve areas (Fig. 2b), and no

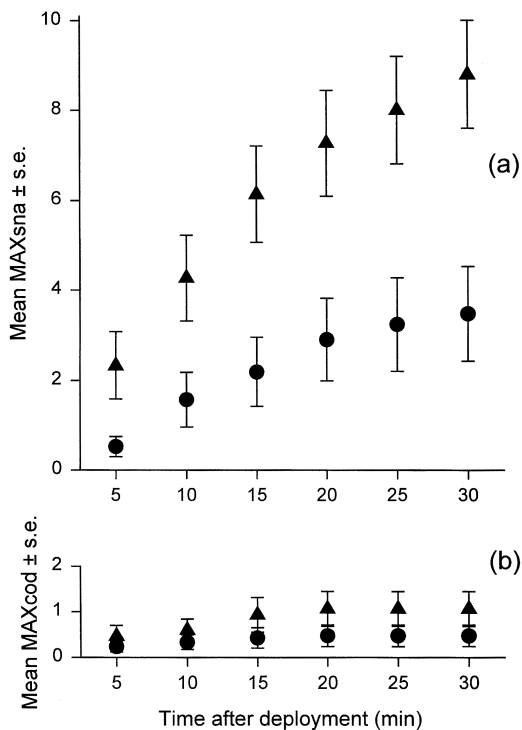

Fig. 2. Mean maximum number of (a) *Pagrus auratus* and (b) *Parapercis colias* detected at different video sequence lengths, from samples taken from reserve (▲, $n = 15$) and non-reserve (●, $n = 21$) areas.

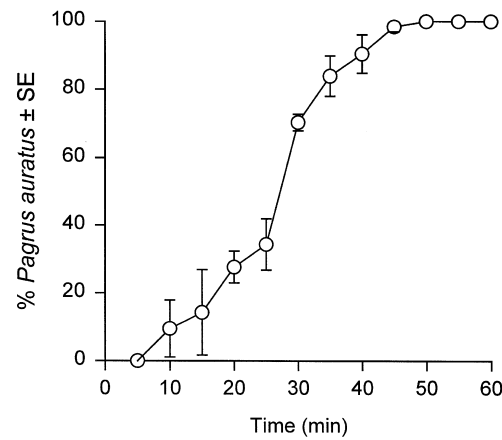

Fig. 3. Mean percent of total *Pagrus auratus* detected at video sequence lengths up to 60 min, taken from sites in the Leigh marine reserve with high fish densities ($n = 3$).

further fish were observed to approach the bait after this time. There was no statistically significant difference in blue cod density between reserve and non-reserve areas ($\chi^2 = 2.21$, *df* 1,34, $P = 0.14$).

Large-scale relative density of snapper and blue cod

Estimates of the relative density of both snapper and blue cod by survey area were significantly different between UVC and BUV (Fig. 4). Lack of congruence between methods resulted in a significant method \times area interaction for both species ($\chi^2 = 15.39$, *df* 7,180, $P < 0.05$). UVC estimates of snapper abundance are so close to zero (range 0.00–0.39 fish 125 m⁻²) as to be practically meaningless.

Snapper were ~2.6 (95% confidence interval bounds for ratio were 1.33 and 4.87) times denser within the Hahei reserve than outside it according to 30 min BUV estimates ($\chi^2 = 8.50$, *df* 1,34, $P < 0.01$, Fig. 5a). Meaningful statistical comparison of UVC estimates was precluded by the extremely low numbers of fish detected (reserve, $n = 19$ from 72 transects; non-reserve, $n = 1$ from 79 transects; Fig. 5a). Only 24 BUV samples (12 reserve and 12 non-reserve) would have been required to detect a three-fold increase in snapper density in reserve relative to non-reserve sites with statistical power of >0.8. By comparison, a total of 10⁵ UVC transects would have given power of only 0.53 for the same effect size.

The relative density of blue cod in reserve and non-reserve areas was estimated to be higher within the reserve by both survey methods (Fig. 5b). UVC indicated that densities were very low, but that there were 4.2 times (95% C.I. bounds 1.96 to 8.81) the density of blue cod within the reserve than in non-reserve areas ($\chi^2 = 16.78$, *df* 1,158, $P < 0.01$). BUV detected greater numbers of fish than UVC overall, but with a reserve mean only 2.4 times (95% C.I. bounds 0.76 to 6.61) higher than the non-reserve mean (Fig. 5b). This was an effect size insufficient to be statistically significant ($\chi^2 = 2.21$, *df* 1,34, $P > 0.1$),

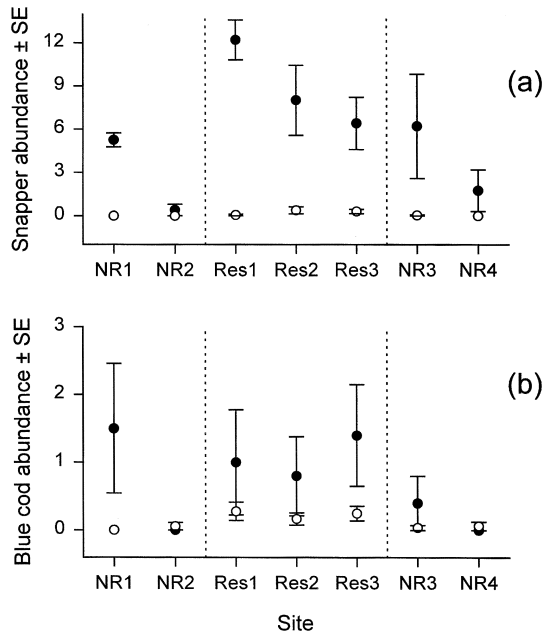

Fig. 4. Site means of (a) *Pagrus auratus* and (b) *Parapercis colias* density taken by BUV (●) and UVC (○) at the Hahei marine reserve. Areas prefixed ‘NR’ are non-reserve, and areas prefixed ‘Res’ are within the reserve. Dotted lines indicate reserve boundaries.

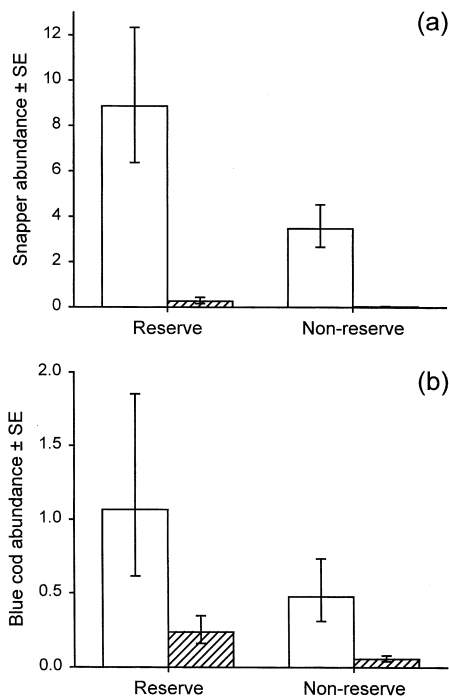

Fig. 5. Total reserve and non-reserve means of (a) *Pagrus auratus* and (b) *Parapercis colias* density taken by BUV (open bars) and UVC (hatched bars) at the Hahei marine reserve. Error bars are 1 s.e. – note that they are unequal about the point estimate because they are calculated on the log scale, and hence are multiplicative on the arithmetic scale.

given the high between-sample variability. *Post hoc* power analysis estimated that a three-fold difference would have been detected (at power = 0.8) by approximately doubling ($n = 76$) the number of BUV deployments, or by doing 1000 UVC transects.

The number of snapper detected by BUV, coupled with the reliability of the measurement method, also allowed comparison of the size structure in reserve and fished habitats. Reserve snapper were significantly (one-way ANOVA, $F_{1,178} = 39.89$, $P < 0.01$) larger than non-reserve fish, with mean lengths of 291 mm (± 7 s.e.) and 218 mm (± 6 s.e.) respectively. The snapper lengths estimated by UVC were too few to be sensibly compared (Fig. 6). The number of blue cod length estimates was also low (BUV, $n = 25$; UVC, $n = 15$). Reserve mean size (293 ± 28 mm) was significantly higher than at non-reserve sites (197 ± 15 mm) on the basis of BUV ($F_{1,22} = 7.37$, $P < 0.05$). The same comparison using UVC data was not statistically significant ($F_{1,13} = 3.93$, $P > 0.05$), although this result is probably an artefact of low sample size coupled with measurement error.

Pairwise, small-scale estimates of blue cod density

The video system does not provide true density estimates, in terms of number of fish per unit area. Rather, it supplies estimates of the number of fish within the range of detection of the bait odour plume. Therefore, for the pairwise video-visual comparisons the total number of blue cod seen by the divers in the six transects (VISUAL) was compared with the MAXcod index value. Correlation analyses (Spearman rank correlation and Pearson product moment coefficients) were used to compare BUV and UVC estimates of abundance. Both methods of analysis provided similar results, so only the Pearson analysis is presented (Table 1). The MAXcod index was most closely correlated to the visual counts, although t_{1STCOD} was also significantly (negatively) correlated, indicating that blue cod arrive at the bait more quickly when their density in the surrounding area is higher. The time at which the maximum numbers of blue cod were present was independent

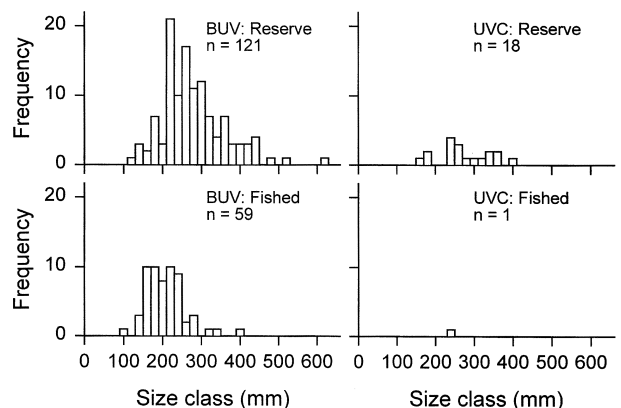

Fig. 6. Size frequency distributions of *Pagrus auratus* determined from BUV and UVC inside and outside Hahei marine reserve.

Table 1. Correlation between video indices and visual estimates of blue cod (*Parapercis colias*) abundance from paired video deployments and diver transects ($n = 16$)

Pearson product moment correlation coefficients (r) are given above their respective P -values in parenthesis ($\text{Prob} > |R|$, $H_0: \rho = 0$, significant values are in bold type). VISUAL, total number seen on diver transects; MAXcod, maximum number in a single frame of videotape; $t_{1\text{STCOD}}$, time to appearance of first cod; t_{MAXcod} , time at which maximum number visible; t_{BG} , time at which external bait lost

	MAXcod	$t_{1\text{STCOD}}$	t_{MAXcod}	t_{BG}
VISUAL	0.90 (<0.01)	-0.65 (<0.01)	-0.18 (0.49)	-0.57 (0.02)
MAXcod		-0.66 (<0.01)	-0.33 (0.21)	-0.38 (0.14)
$t_{1\text{STCOD}}$			0.66 (<0.01)	0.75 (<0.01)
t_{MAXcod}				0.39 (0.13)

of abundance. The persistence of external bait (t_{BG}) decreased with increasing VISUAL abundance, although t_{BG} was not significantly correlated with the MAXcod index. Of greater interest is the strong significant relationship between t_{BG} and $t_{1\text{STCOD}}$, indicating that blue cod, rather than snapper, are usually responsible for removal of the external bait. This is corroborated by direct observation of the video footage.

The relationship between VISUAL and MAXcod was described by a simple linear regression model (Fig. 7) with the equation $y = 0.608x + 0.729$ ($R^2 = 0.808$). The data were significantly correlated (Pearson's product moment coefficient $r = 0.90$, $t_{14} = 8.64$, $P < 0.001$). The fitting of 95% confidence intervals indicated that the two methods provided similar estimates of relative abundance for blue cod (see also Table 1).

Discussion

This study has demonstrated baited underwater video surveys to be an effective (and sometimes superior) alternative to UVC methods for estimating relative densities of predatory reef fish. Remote-sampling methods can be operated in low-visibility conditions and at greater depths than the capabilities of SCUBA divers, require fewer personnel, remove bias caused by spatial variability in fish behaviour, and are less likely to return low (or zero) abundance estimates for large carnivorous species, meaning that the statistical power of comparisons is likely to be greater with lower field costs than diving operations. The system does have operational limitations, however. Substrata with high vertical relief or high current conditions can cause the camera stand to become unstable, which may frighten away fish responding to the bait. Additionally, the field of view may be obscured by kelp on shallow reefs, inhibiting the accuracy of counts and length measurements. For the enumeration of mobile demersal fishes, placement of the camera on flat sand adjacent to reefs has been the most effective strategy.

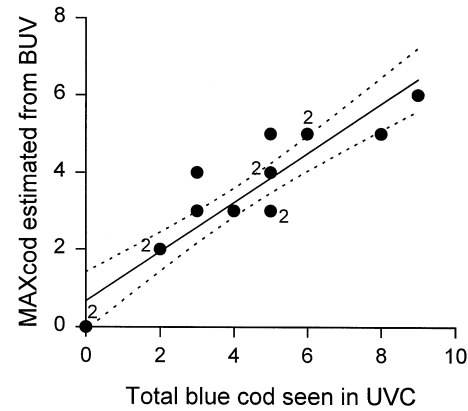

Fig. 7. Comparison of video MAXcod index and diver survey counts of *Parapercis colias* at 16 localities. Five values are obscured (indicated by numbers). Dashed lines are 95% confidence intervals around the fitted linear regression (solid line).

At the Hahei marine reserve, BUV detected snapper in all survey areas, and we estimate that more than twice as many fish were present inside the reserve than outside. The sample size used was in excess of the necessary minimum to detect a three-fold difference in relative density of snapper. On the other hand, even if the UVC snapper data could have been modelled, the biological significance of any statistically significant test would have been suspect. So few snapper were detected by UVC that we would be unwilling to attribute differences to reserve effects, as opposed to chance. Furthermore, greater numbers of fish seen inside the reserve may merely be an artefact of changes in their behaviour (Cole 1994; Jennings and Polunin 1995; Kulbicki 1998), and therefore visibility to divers, rather than indicating any real change in density. It is also possible that behavioural changes within reserves might also alter fish responses to bait, or the introduction of any novel structure (such as the BUV stand). This was not investigated in this study, and there is much scope to examine the effect of varying fishing pressure upon the behavioural component of catchability. Similarly, repeated deployments of a baited structure within a resident population may train fish to respond to the presence of the structure, resulting in exactly the same between-site bias we are attempting to avoid. To date, our surveys have been done at six-month intervals, which is unlikely to be frequent enough to alter behaviour. Also, the surveys follow a randomized block design, meaning that replicate deployments are unlikely to be made in exactly the same locations on consecutive surveys.

The maximum number of fish seen on a 30 min video sequence was the best BUV index of relative abundance (i.e. MAXsna and MAXcod). This was clearest from small-scale comparisons of blue cod abundance obtained from the video camera. Of the time-based measures, $t_{1\text{STCOD}}$ was the best, and it appears that blue cod responses to bait are relatively

predictable, and that the speed of arrival of the first fish does reflect abundance. The remaining indices were not particularly useful as abundance measures, because they reflected responses of individual fish, and were largely dependent upon the chance location and behavioural reaction of those individuals when the camera was deployed. These data were relatively variable and did not always reflect the abundance measures made by other methods. There is undoubtedly an upper limit to the number of fish that may be visible in the field of view at a given moment, which may cause BUV to underestimate abundance where densities are very high. This will produce conservative contrasts between areas with high and low fish density, but may result in failure to detect a difference between two areas where densities are different, but so high as to saturate the field of view in both places. In practice, the latter situation is unlikely to occur with snapper, because most values of MAXsna we obtained were <60% of the highest value yet recorded. The highest MAXsna value obtained to date is 26 (at Leigh marine reserve, Willis unpublished). At Hahei, the range of MAXsna values was 0–16 with a median of 6, so saturation of the BUV field of view in high-density areas should not have biased the mean estimates obtained at Hahei. Variation in dispersal of the bait plume (caused by small-scale variation in current strength) is likely to contribute to within-area variance. At present this is dealt with by ensuring that at least four replicate deployments are made within each survey area, as indicated by power analysis. A more accurate but more labour-intensive approach would be to attach to the stand a data logger that records current velocity and direction during each deployment. The area covered by the bait plume could then be estimated from diffusion models (e.g. Priede and Merrett 1996).

It was clear that the MAXcod index obtained by BUV accurately reflected the abundance of blue cod as determined by UVC small-scale (pairwise) comparisons. However, higher numbers of blue cod were often detected by UVC than by BUV at each site (slope of regression line <1), which may be due to several factors. Where there was strong current, the bait odour plume probably dispersed in only one direction (fish tended to approach the bait from down-current) whilst both visual and auditory stimuli from divers may have attracted fish from several directions. Similarly, divers may have surveyed a greater area of substratum than that covered by the bait plume (regardless of current). Finally, large blue cod (and snapper) sometimes became aggressive after 5–10 min and were often observed to actively defend the bait, which may have prevented other fish (particularly juvenile blue cod) from entering the camera's field of view.

The large-scale comparisons of blue cod were less convincing, but this may be partly an artefact of naturally low densities of this species in the survey area, coupled with its more specific habitat requirements. Had we specifically stratified the survey by habitat, variances around blue cod estimates might have been much reduced. Small-scale

BUV–UVC comparisons could not be made for snapper, because few fish were detected by UVC except in areas where fish were diver-positive in their behaviour (Cole 1994). Previous large-scale comparisons of snapper density (determined from BUV) with angling surveys (Millar and Willis 1999) found the results of these methods to be well correlated (Willis *et al.* 2000). These findings contrast with those of Priede *et al.* (1990), Armstrong *et al.* (1992) and Priede and Merrett (1996), who found that the maximum number of the deep-sea fish *Coryphaenoides (Nematomurus) armatus* responding to bait was uncorrelated with abundance estimates from trawl surveys. Conversely, Ellis and DeMartini (1995) found good agreement between video MAXno and long-line surveys for *Pristipomoides filamentosus* in shallower waters (73–85 m) off Hawaii. Comparison of our studies and those above provides a basis for improving the consistency of fish surveys using remote imaging.

Ellis and DeMartini (1995) suggested that a major cause of the discrepancy between their results and those of workers in abyssal depths was that the Hawaiian study employed enclosed baits, whereas the deep-sea studies used baits that were accessible to the fish. Removal of baits by *C. (N.) armatus* may well have affected the accumulation of fish under the camera. During BUV trials prior to the present study, the lid of the bait holder was lost on two occasions and the bait was quickly consumed by snapper, which dispersed rapidly thereafter.

We suggest a further difference between the abyssal studies and the present study and Ellis and DeMartini (1995), which may have influenced their MAX index. First, because Priede and colleagues work in great depths over relatively long deployment times, they used time-lapse video and still cameras with 10–20 s sequences at 5–15 min intervals (Priede *et al.* 1990) and photographs at 1 min intervals (Priede and Merrett 1996), respectively. Different species may respond to bait in different ways, but in the course of the present study it was noted that fish of all species often moved in and out of the field of view. Our MAX indices were obtained from continuous monitoring of the sequence, and maxima rarely coincided with predetermined sampling intervals. It is therefore likely that non-continuous monitoring results in potentially important losses of information.

Although deployment duration of 30 min probably did not detect all snapper within the range of the bait plume, sample sequences of this length provided consistent estimates of relative density between reserve and fished areas. Longer video sequences incurred greater costs in terms of both field time and laboratory analysis without substantial added benefit to data quality, or to our ability to make comparisons of relative abundance.

The greater ability of the BUV system to detect differences in the relative density of snapper is well illustrated by comparison with the results of concurrent UVC surveys. We are continuing to use BUV for longer-term monitoring of snapper in several temperate reserves (Willis unpublished),

and suggest that the system may be appropriate for the survey of large, carnivorous fishes in other temperate and tropical reef environments.

The species first exploited in marine fisheries are usually top-level predators (Pauly *et al.* 1998), and it is these larger carnivores that would therefore be expected to respond most rapidly to marine reserve protection. Unfortunately, these species often also exhibit the most behavioural plasticity (Jennings and Polunin 1995; Kulbicki 1998), which may limit the effectiveness of UVC methods for making between-site comparisons of abundance (Cole 1994; Connell *et al.* 1998; Willis *et al.* 2000). Desktop modelling studies (e.g. DeMartini 1993; Mangel 1998) have supported many of the potential benefits of marine reserves to fishery management (Roberts and Polunin 1991; Dugan and Davis 1993; Rowley 1994). However, to date these benefits are almost completely unsupported by empirical data, especially in temperate regions. It is likely that this dearth of field evidence in support of the theoretically possible is at least partly due to the continued reliance by ecologists on UVC techniques for marine reserve assessment.

The advent of relatively cheap technology such as BUUV means that a reassessment of the idea that a single method (UVC) can, or should, be used to census all fish species is overdue. We do not claim that UVC is without application, merely that researchers need to consider carefully which species are to be enumerated and why, and then employ the most appropriate method to achieve their goals.

Acknowledgements

Field assistance at Leigh was provided primarily by M. Birch (who built the video stand), J. Archer, B. Doak, J. Saunders, E. Skipworth and A. Thomas. Field assistance at Hahei was ably given by B. Doak, S. Henderson, M. Kearney, and J. Saunders. Discussions with R. Rae during the first Hahei survey led to the construction of a more effective video stand. B. Doak and M. Birch helped find practical solutions to various technical issues, and we are grateful for their interest and support. The video camera and cabling were assembled and maintained by P. Thompson, P. Carter (DoC) provided logistic support at Hahei, and R. Millar helped with the analyses. Improvements to the manuscript were made by R. Creese and N. Tolimieri. This study was funded by Department of Conservation Grant No. 1946, and the University of Auckland Research Committee.

References

- Agardy, M. T.** (1994). Advances in marine conservation: the role of marine protected areas. *Trends in Ecology and Evolution* **9**, 267.
- Allison, G. W., Lubchenco, J., and Carr, M. H.** (1998). Marine reserves are necessary but not sufficient for marine conservation. *Ecological Applications* **8** (Suppl.), 79–92.
- Andrew, N. L., and Mapstone, B. D.** (1987). Sampling and the description of spatial pattern in marine ecology. *Oceanography and Marine Biology Annual Review* **25**, 39–90.
- Armstrong, J. D., Bagley, P. M., and Priede, I. G.** (1992). Photographic and acoustic tracking observations of the behaviour of the grenadier *Coryphaenoides (Nematonurus) armatus*, the eel *Synaphobranchus bathybius*, and other abyssal demersal fish in the North Atlantic Ocean. *Marine Biology* **112**, 535–44.
- Babcock, R. C., Kelly, S., Shears, N. T., Walker, J. W., and Willis, T. J.** (1999). Changes in community structure in temperate marine reserves. *Marine Ecology Progress Series* **189**, 125–34.
- Bell, J. D., Craik, G. J. S., Pollard, D. A., and Russell, B. C.** (1985). Estimating length frequency distributions of large reef fish underwater. *Coral Reefs* **4**, 41–4.
- Cheal, A. J., and Thompson, A. A.** (1997). Comparing visual counts of coral reef fish: implications of transect width and species selection. *Marine Ecology Progress Series* **158**, 241–8.
- Cole, R. G.** (1994). Abundance, size structure, and diver-oriented behaviour of three large benthic carnivorous fishes in a marine reserve in northeastern New Zealand. *Biological Conservation* **70**, 93–9.
- Cole, R. G., Ayling, T. M., and Creese, R. G.** (1990). Effects of marine reserve protection at Goat Island, northern New Zealand. *New Zealand Journal of Marine and Freshwater Research* **24**, 197–210.
- Connell, S. D., Samoily, M. A., Lincoln-Smith, M. P., and Leqata, J.** (1998). Comparisons of abundance of coral-reef fish: catch and effort surveys vs visual census. *Australian Journal of Ecology* **23**, 579–86.
- Davidson, R. J.** (1997). Biological monitoring of Long Island–Kokomohua Marine Reserve, Queen Charlotte Sound, Marlborough Sounds: update September, 1993 – April, 1997. Unpublished report to the N.Z. Department of Conservation. 40 pp. [Held in DoC library, Nelson, New Zealand.]
- DeMartini, E. E.** (1993). Modeling the potential of fishery reserves for managing Pacific coral reef fishes. *Fishery Bulletin* **91**, 414–27.
- Dugan, J. E., and Davis, G. E.** (1993). Applications of marine refugia to coastal fisheries management. *Canadian Journal of Fisheries and Aquatic Sciences* **50**, 2029–42.
- Edgar, G. J., and Barrett, N. S.** (1997). Short term monitoring of biotic change in Tasmanian marine reserves. *Journal of Experimental Marine Biology and Ecology* **213**, 261–79.
- Ellis D. M., and DeMartini, E. E.** (1995). Evaluation of a video camera technique for indexing abundances of juvenile pink snapper, *Pristipomoides filamentosus*, and other Hawaiian insular shelf fishes. *Fishery Bulletin* **93**, 67–77.
- Hickford, M. J. H., and Schiel, D. R.** (1995). Catch vs count: effects of gill-netting on reef fish populations in southern New Zealand. *Journal of Experimental Marine Biology and Ecology* **188**, 215–32.
- Hurlbert, S. H.** (1984). Pseudoreplication and the design of ecological field experiments. *Ecological Monographs* **54**, 187–211.
- Jennings, S., and Polunin, N. V. C.** (1995). Biased underwater visual census biomass estimates for target-species in tropical reef fisheries. *Journal of Fish Biology* **47**, 733–6.
- Jones, G. P., Cole, R. G., and Battershill, C. N.** (1993). Marine reserves: do they work? In 'Proceedings of the Second International Temperate Reef Symposium'. (Eds C.N. Battershill et al.) pp. 29–45. (NIWA Marine: Wellington.)
- Kingsford, M. J., and Battershill, C. N.** (1998). Procedures for establishing a study. In 'Studying Temperate Marine Environments'. (Eds M. Kingsford and C. Battershill.) pp. 29–48. (Canterbury University Press: Christchurch.)
- Kulbicki, M.** (1998). How the acquired behaviour of commercial reef fishes may influence the results obtained from visual censuses. *Journal of Experimental Marine Biology and Ecology* **222**, 11–30.
- Lincoln Smith, M. P.** (1988). Effects of observer swimming speed on sample counts of temperate rocky reef fish assemblages. *Marine Ecology Progress Series* **43**, 223–31.
- Lincoln Smith, M. P.** (1989). Improving multispecies rocky reef censuses by counting different groups of species using different procedures. *Environmental Biology of Fishes* **26**, 29–37.

- Mangel, M.** (1998). No-take areas for sustainability of harvested species and a conservation invariant for marine reserves. *Ecology Letters* **1**, 87–90.
- McCormick, M. I.** (1989). Spatio-temporal patterns in the abundance and population structure of a large temperate reef fish. *Marine Ecology Progress Series* **53**, 215–25.
- McCormick, M. I., and Choat, J. H.** (1987). Estimating total abundance of a large temperate-reef fish using visual strip transects. *Marine Biology* **96**, 469–78.
- Millar, R. B., and Willis, T. J.** (1999). Estimating the relative density of snapper in and around a marine reserve using a log-linear mixed effects model. *Australian and New Zealand Journal of Statistics* **41**, 383–94.
- Pauly, D., Christenson, V., Dalsgaard, J., Froese, R., and Torres, F.** (1998). Fishing down marine food webs. *Science* **279**, 860–3.
- Power, J. H., and Moser, E. B.** (1999). Linear model analysis of net catch data using the negative binomial distribution. *Canadian Journal of Fisheries and Aquatic Sciences* **56**, 191–200.
- Priede, I. G., and Merrett, N. R.** (1996). Estimation of abundance of abyssal demersal fishes: a comparison of data from trawls and baited cameras. *Journal of Fish Biology* **49** (Suppl. A), 207–16.
- Priede, I. G., Smith, K. L., and Armstrong, J. D.** (1990). Foraging behaviour of abyssal grenadier fish: inferences from acoustic tagging and tracking in the North Pacific Ocean. *Deep-Sea Research* **37**, 81–101.
- Roberts, C. M.** (1997). Ecological advice for the global fisheries crisis. *Trends in Ecology and Evolution* **12**, 35–8.
- Roberts, C. M., and Polunin, N. V. C.** (1991). Are marine reserves effective in management of reef fisheries? *Reviews in Fish Biology and Fisheries* **1**, 65–91.
- Rowley, R. J.** (1994). Marine reserves in fisheries management. *Aquatic Conservation: Marine and Freshwater Ecosystems* **4**, 233–54.
- St John, J., Russ, G. R., and Gladstone, W.** (1990). Accuracy and bias of visual estimates of numbers, size structure and biomass of a coral reef fish. *Marine Ecology Progress Series* **64**, 253–62.
- Thompson, A. A., and Mapstone, B. D.** (1997). Observer effects and training in underwater visual surveys of reef fishes. *Marine Ecology Progress Series* **154**, 53–63.
- Thresher, R. E., and Gunn, J. S.** (1986). Comparative analysis of visual census techniques for highly mobile, reef-associated piscivores (Carangidae). *Environmental Biology of Fishes* **17**, 93–116.
- Underwood, A. J.** (1993). The mechanics of spatially replicated sampling programmes to detect environmental impacts in a variable world. *Australian Journal of Ecology* **18**, 99–116.
- Willis, T. J., Millar, R. B., and Babcock, R. C.** (2000). Detection of spatial variability in relative density of fishes: comparison of visual census, angling, and baited underwater video. *Marine Ecology Progress Series* **198**, 249–60.
- Zar, J. H.** (1984). 'Biostatistical Analysis.' (Prentice-Hall: Englewood Cliffs, NJ.)

Manuscript received 21 January 2000; revised and accepted 13 July 2000